

EVERYTHING HAS A NAME

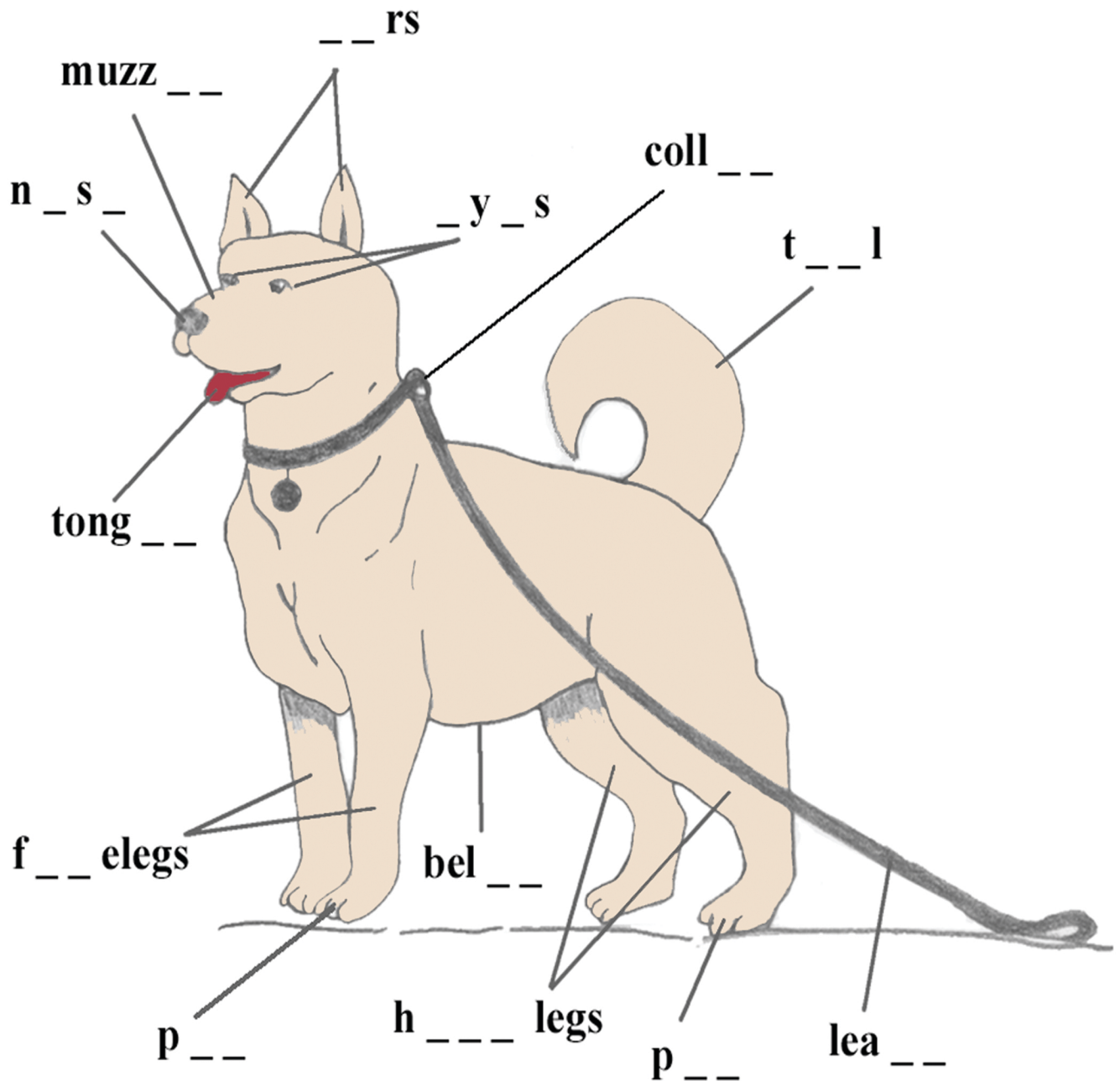

Parts of a Body

(Directions: Trace the picture and fill in the blanks with letters from the Sound Bank.)

- Word Bank**
- shoulder
 - ankle
 - foot
 - chest
 - elbow
 - knee
 - thigh
 - hip
 - waist
 - crown
 - forearm
 - neck
 - wrist
 - hand
 - shin
 - stomach

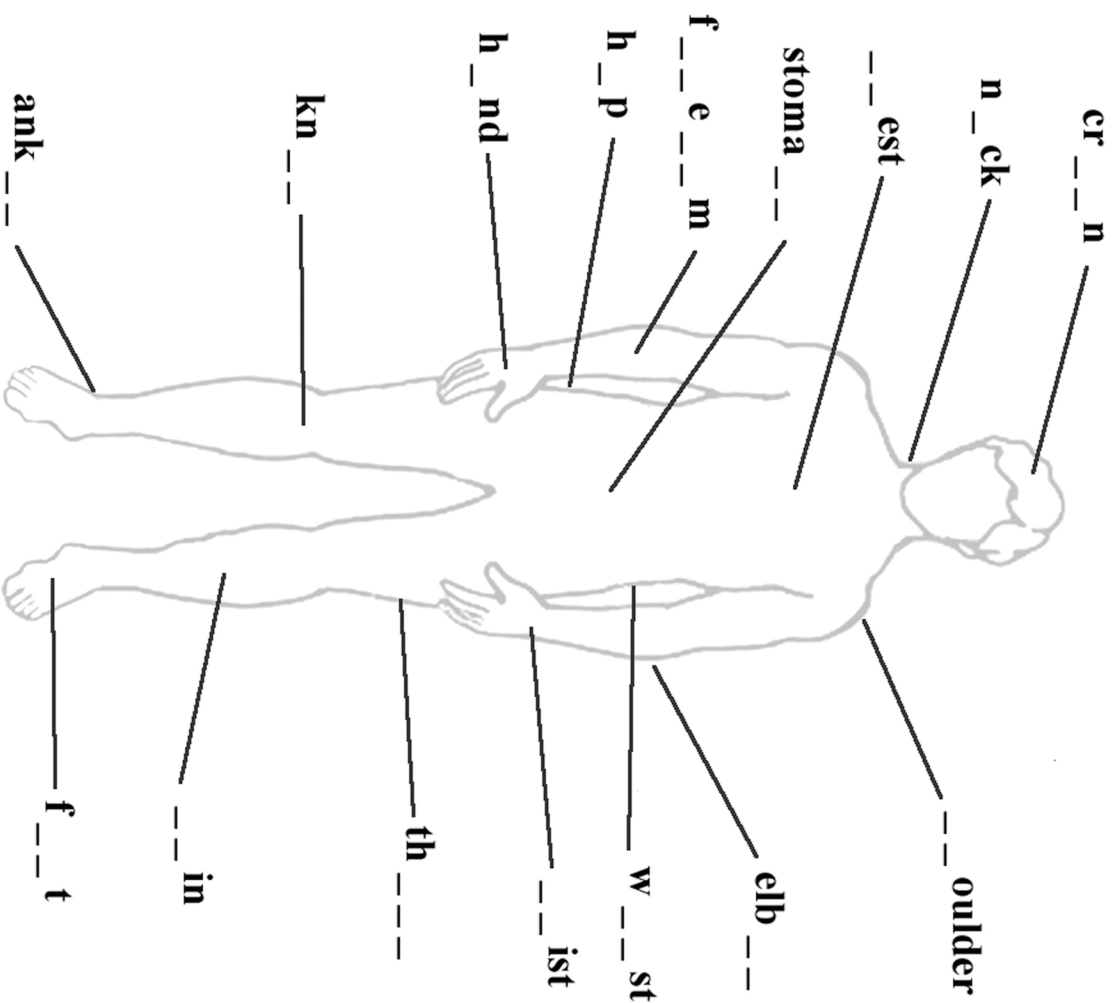

Sound Bank – Use these letters

- ai
- ow
- ow
- i
- ee
- ch
- sh
- sh
- oo
- e
- a
- igh
- wr
- or
- ar
- le
- ch

Parts of a Face

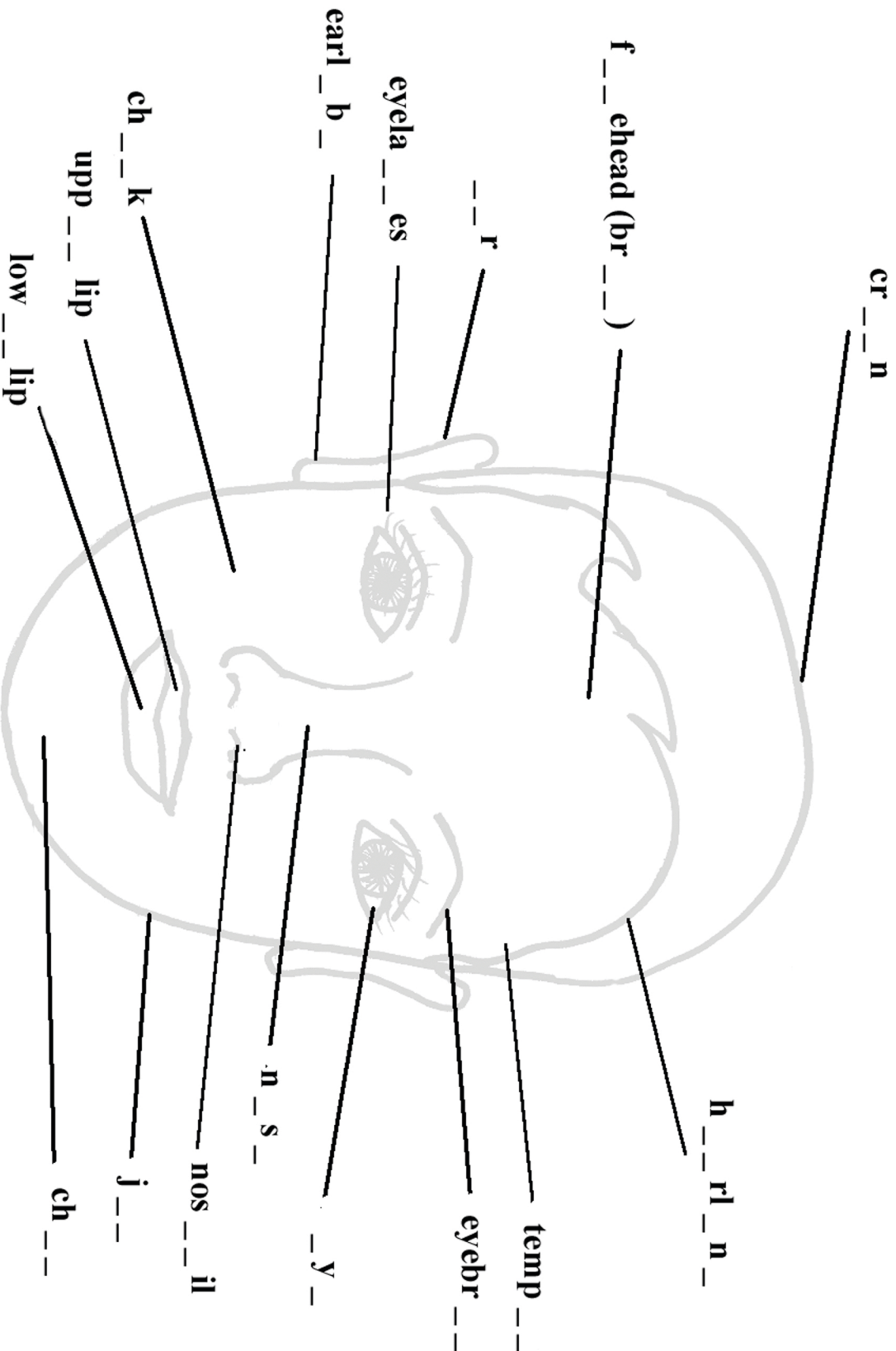

- jaw
- ear
- crown
- nostril
- brow
- hairline
- lower lip
- upper lip
- cheek
- eye
- eyebrow
- forehead
- eyelashes
- chin
- nose
- temple
- earlobe

Sound Bank – Use these letters

or o_e aw er e_e ow o_e le er tr ai i_e ow ee ow in sh ea

Parts of a Face with Hair

Word Bank

mustache
beard
sideburns
eyebrows
hair
eyelashes

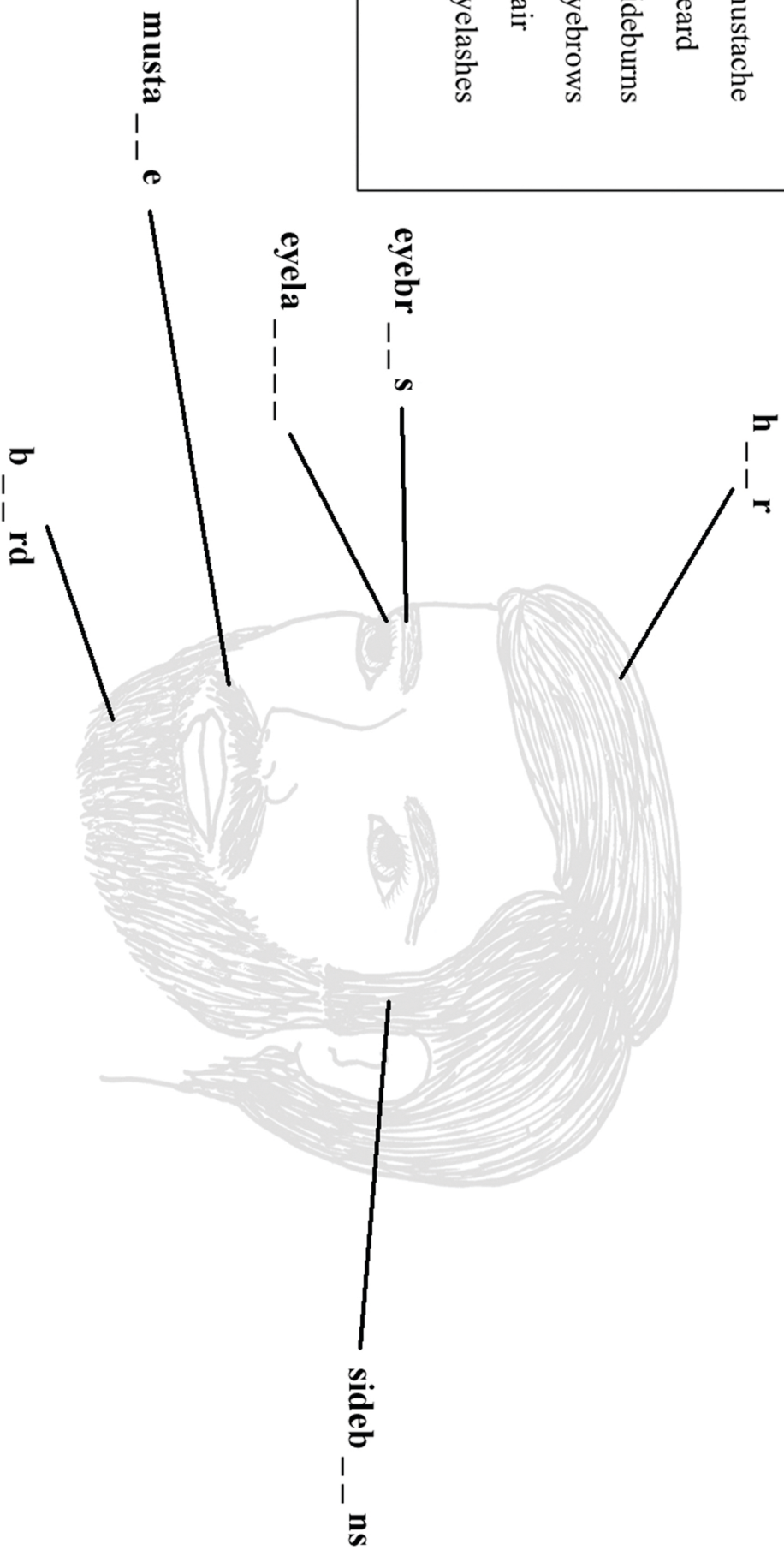

Sound Bank – Use these letters

ai ch ow ea shes ur

Parts of a Foot

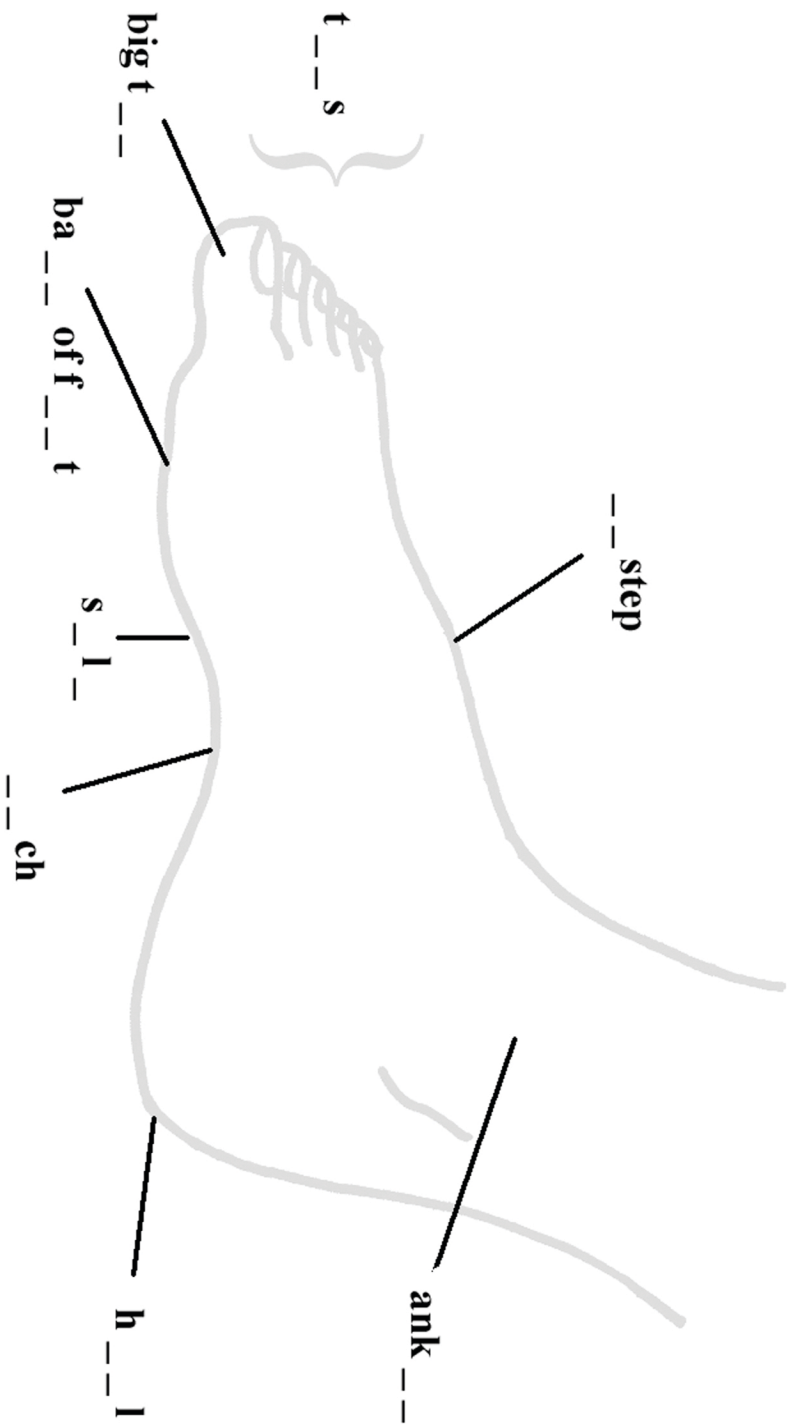

- Word Bank
- instep
 - heel
 - toes
 - arch
 - big toe
 - sole
 - ankle
 - ball of foot

Sound Bank – Use these letters

oe oe o_e le ll ar ee in oo

Parts of the Back of My Hand

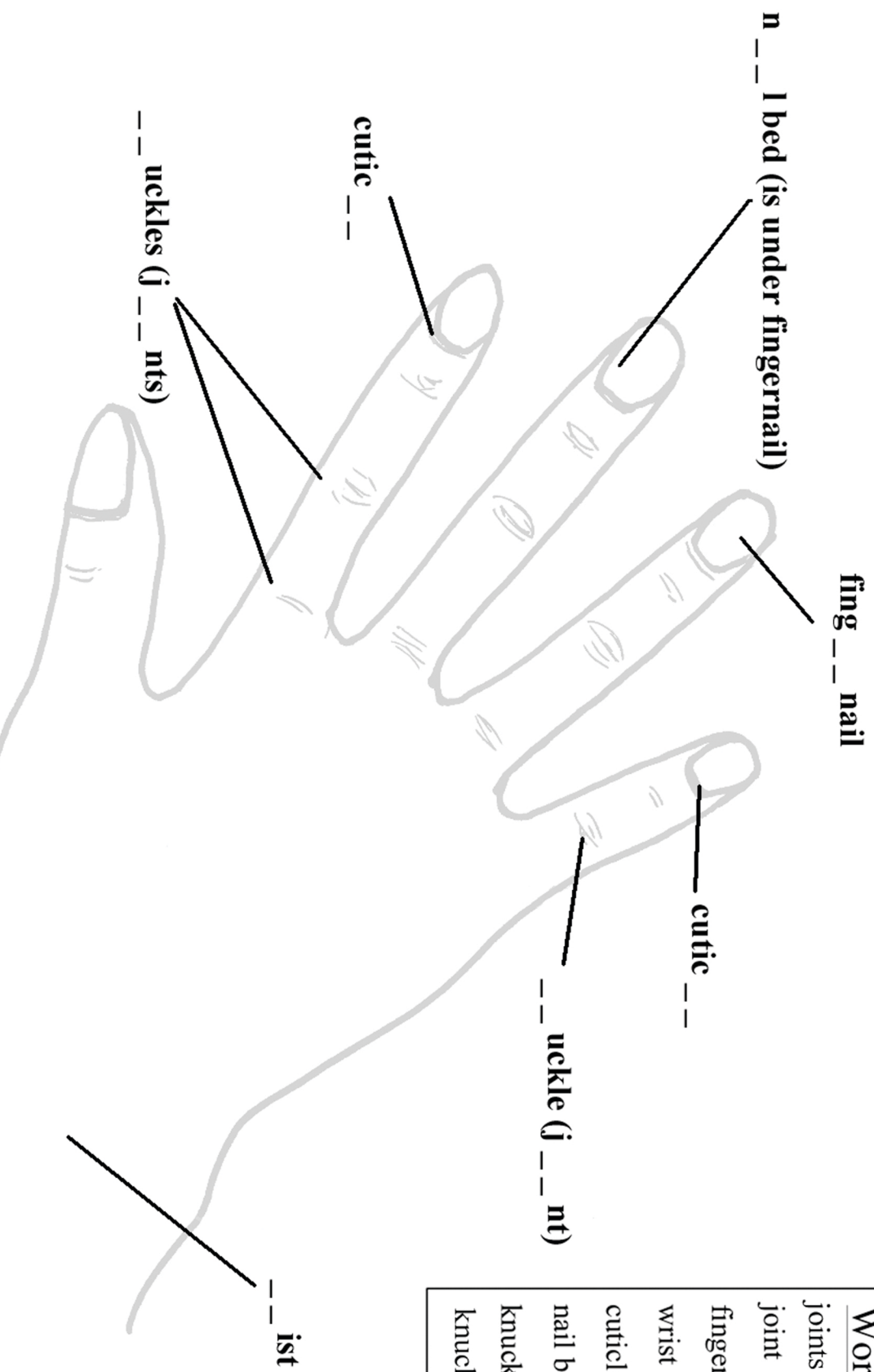

- Word Bank**
- joints
 - joint
 - fingernail
 - wrist
 - cuticle (2)
 - nail bed
 - knuckles
 - knuckle

Sound Bank – Use these letters

- kn
- ai
- le
- er
- oi
- wr
- kn
- oi
- le

Parts of the Inside of My Hand

- Word Bank**
- palm
 - wrist
 - index finger
 - pinkie
 - knuckles
 - ring finger
 - little finger
 - middle finger
 - thumb

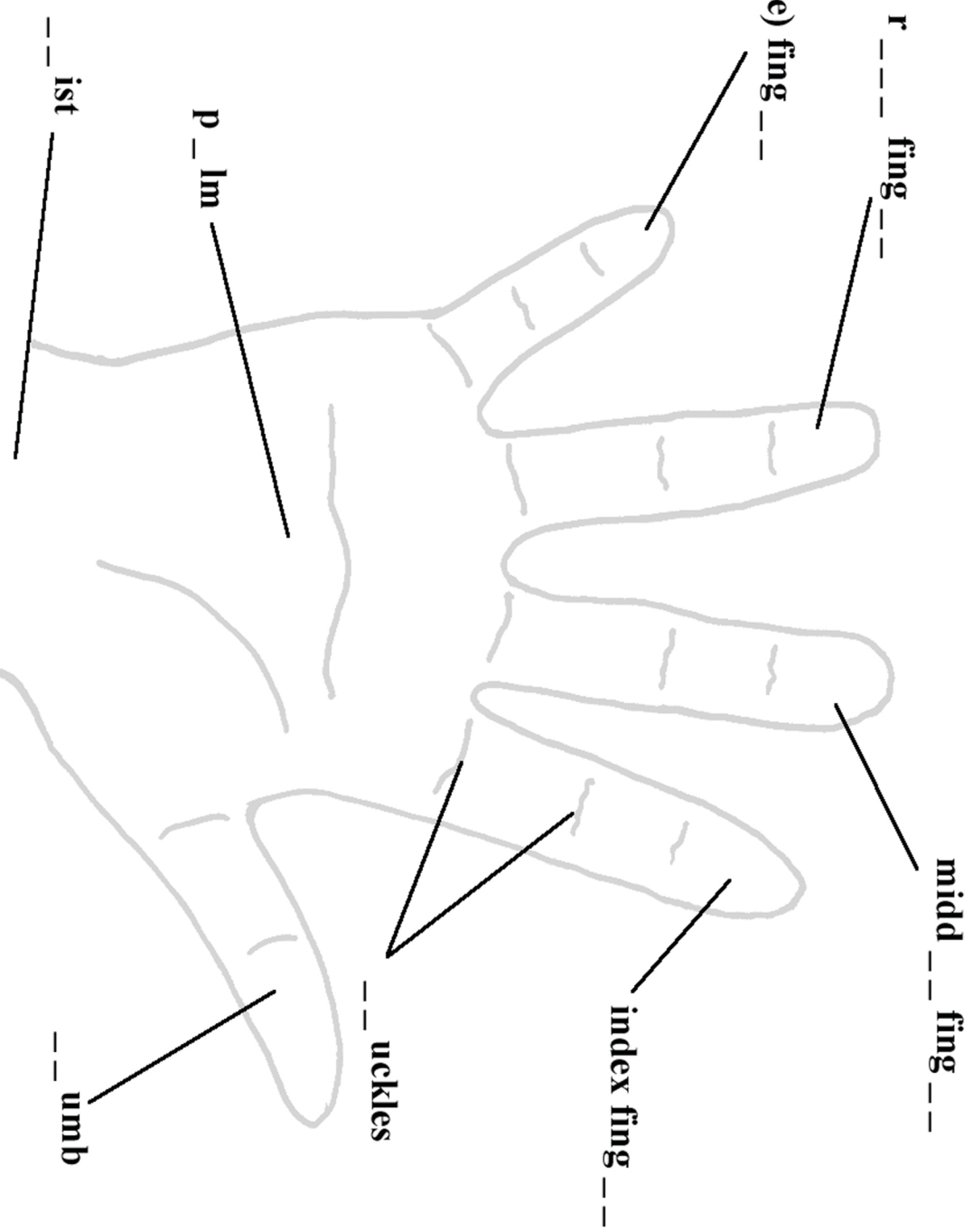

Sound Bank – Use these letters

- le
- wr
- er
- kn
- th
- er
- ing
- a
- er
- i
- le
- er

Parts of a Pair of Long Pants (Slacks) (Trousers)

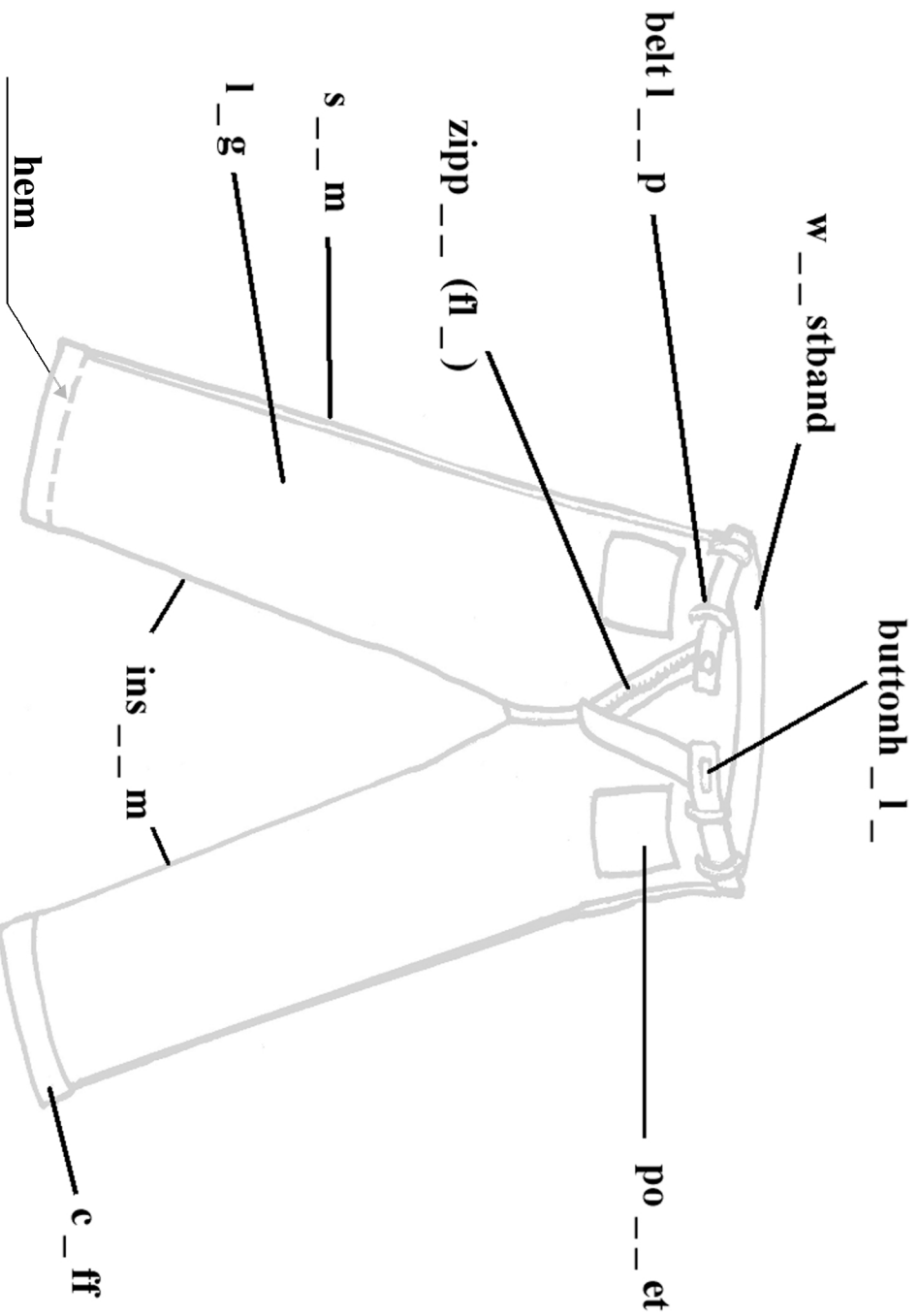

Word Bank

- cuff
- belt loop
- waistband
- leg
- inseam
- seam
- pocket
- buttonhole
- zipper
- fly

Sound Bank – Use these letters

- oo
- ai
- e
- ea
- ck
- er
- o_e
- y
- ea
- u

Parts of a Shirt (Blouse)

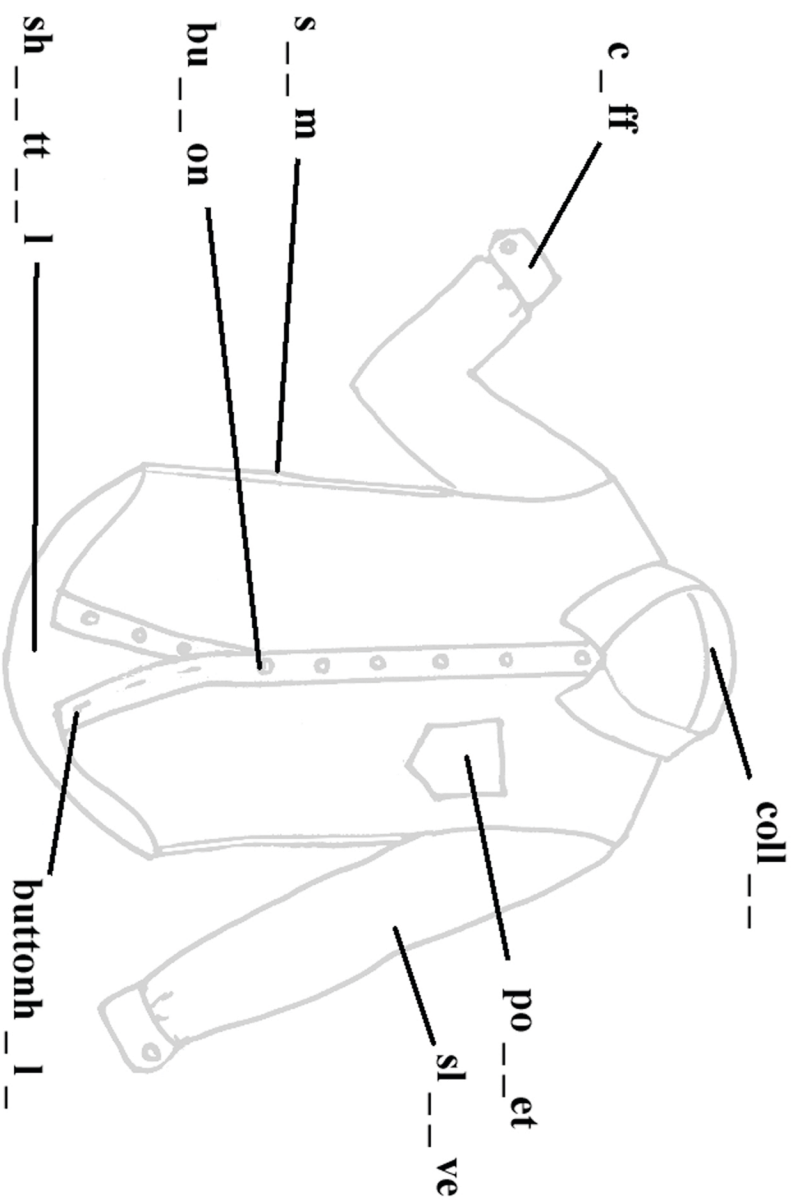

Word Bank

- sleeve
- cuff
- shirttail
- seam
- buttonhole
- button
- collar
- pocket

Sound Bank – Use these letters

ir tt o_e ck u ar ea ai ee

Parts of a Shoe

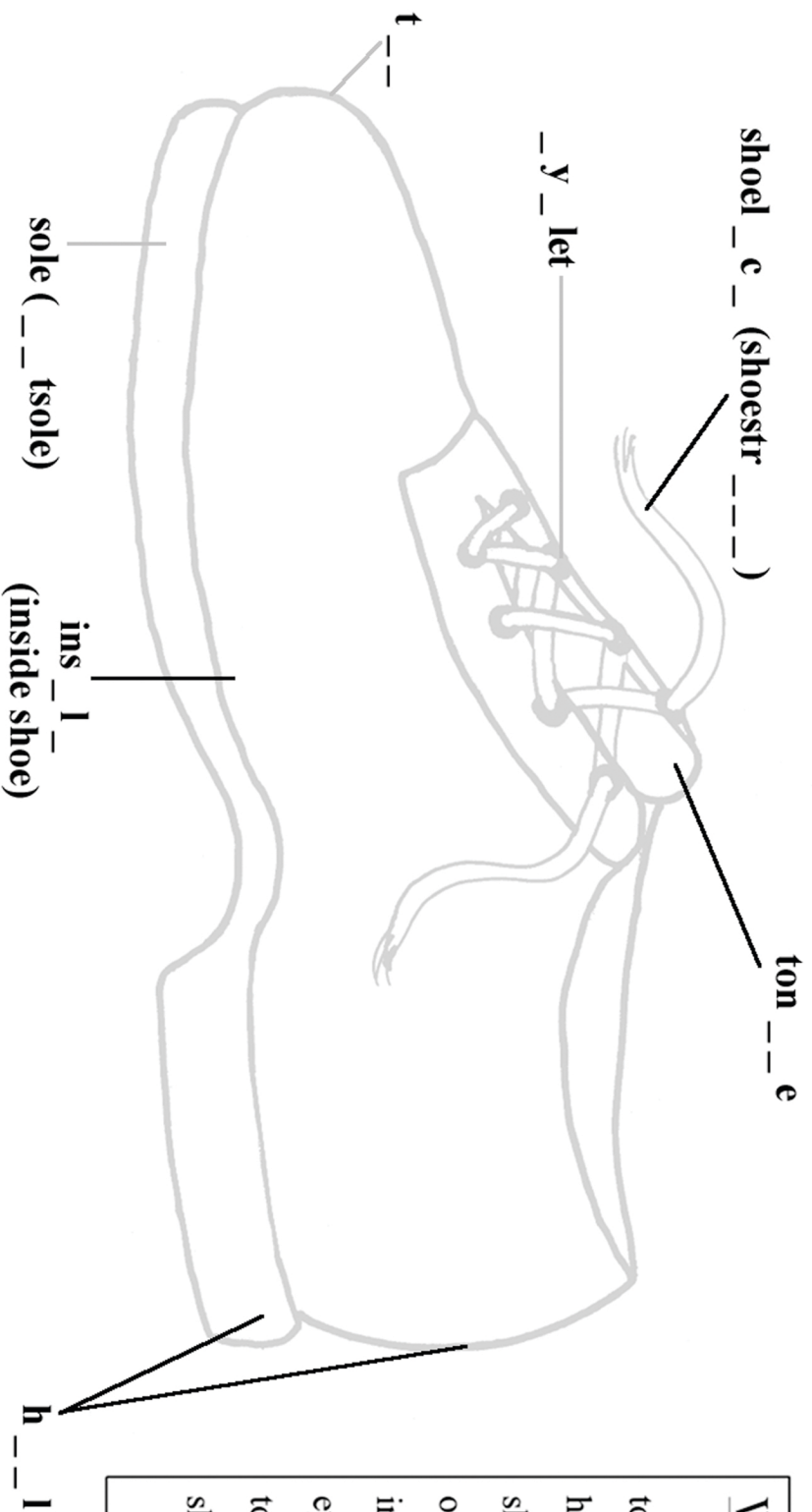

Word Bank

toe
heel
shoelace
outsole
insole
eyelet
tongue
shoestring

Sound Bank – Use these letters

a_e gu ee oe e_e ing ou o_e

Parts of a Backyard

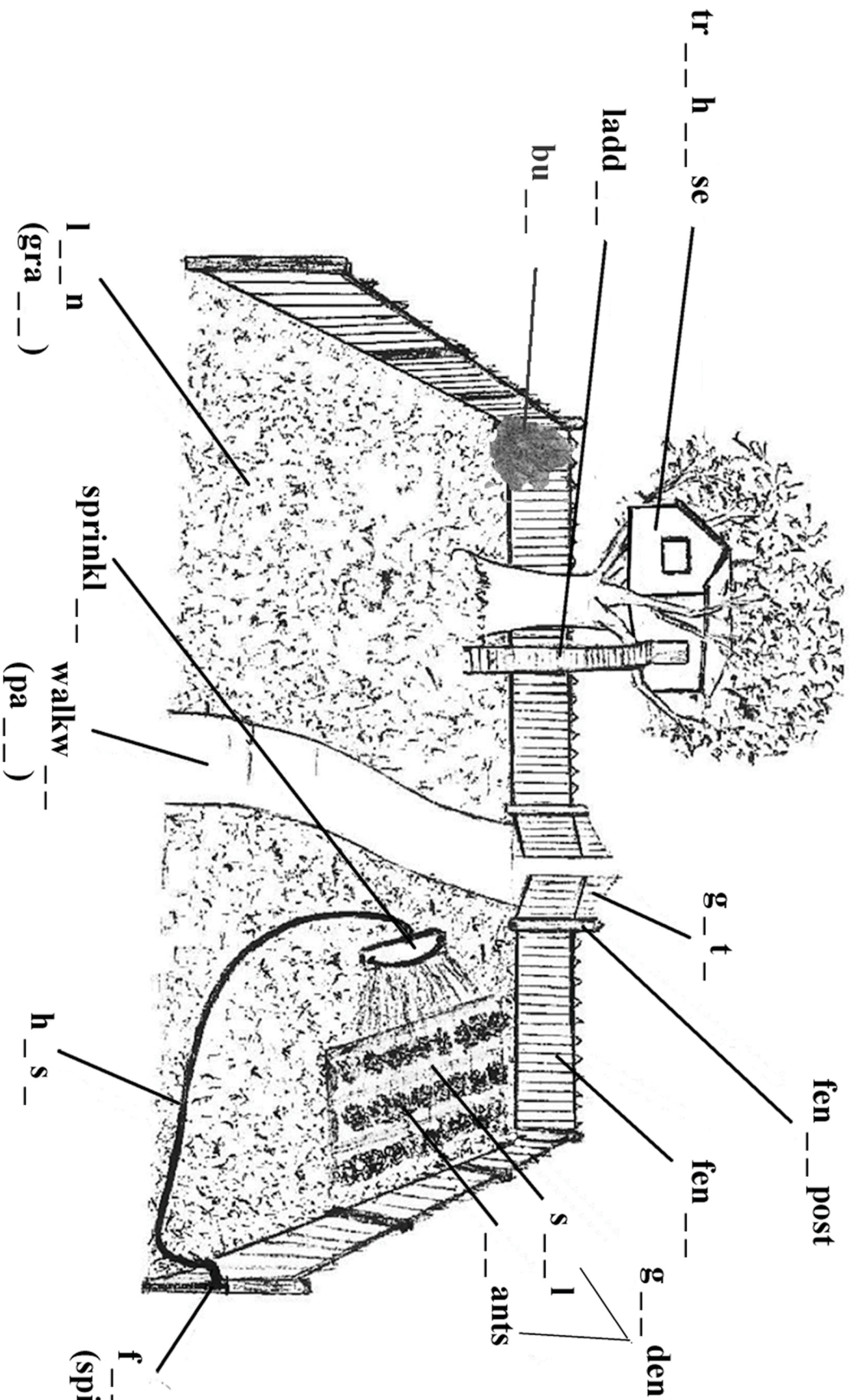

- sprinkler
- plants
- spigot
- walkway
- ladder
- fence post
- soil
- tree house
- gate
- faucet
- grass
- fence
- garden
- lawn
- hose
- path
- bush

Word Bank

Sound Bank – Use these letters

- au
- ce
- er
- ot
- er
- oi
- a_e
- ss
- ar
- o_e
- sh
- pl
- ay
- ce
- ee
- aw
- ou
- th

Parts of a Bedroom

- Word Bank
- closet
 - toy box
 - mirror
 - headboard
 - pillow
 - dresser drawer
 - box spring
 - dresser
 - mattress
 - rug
 - nighstand
 - lamp

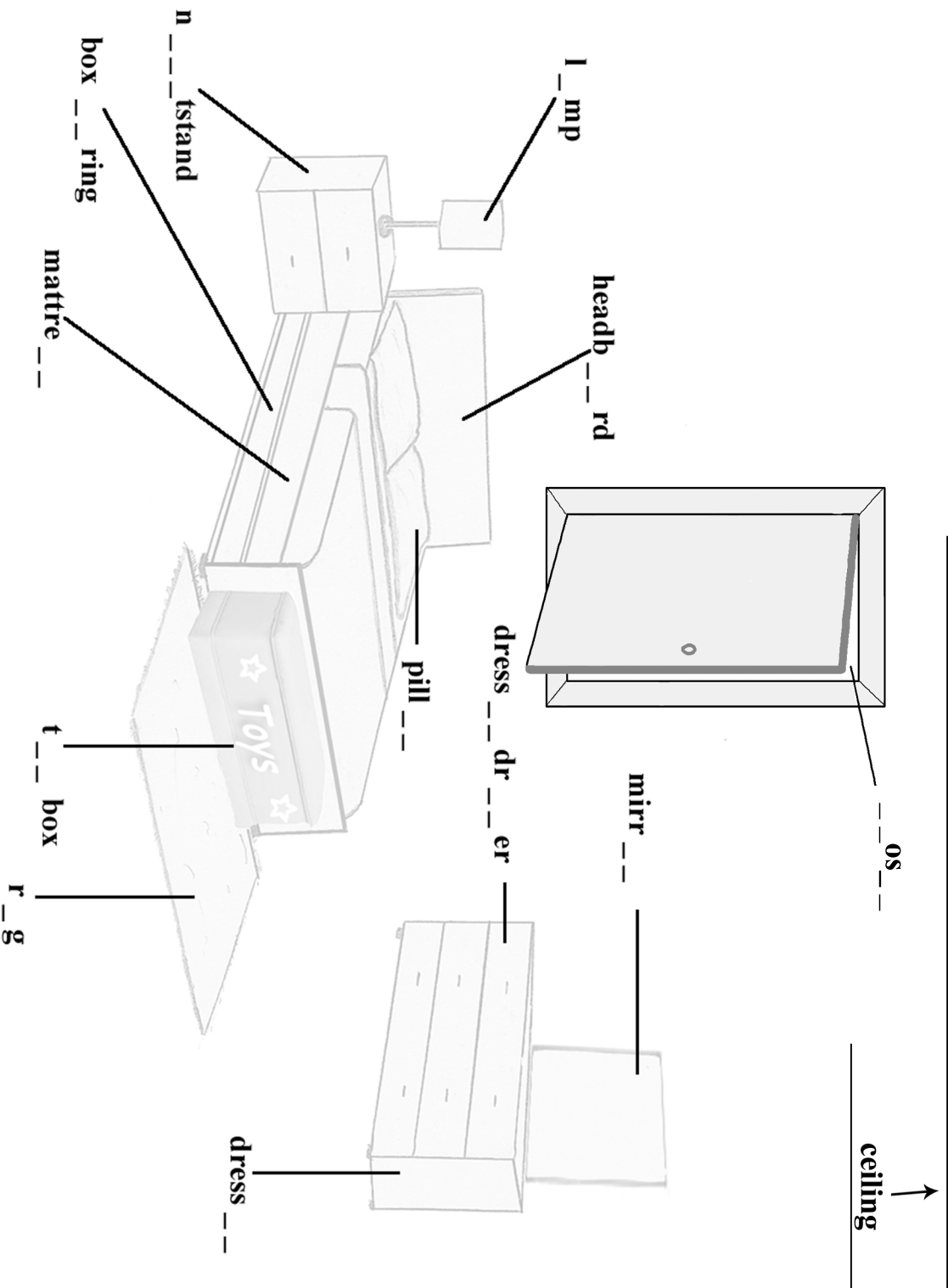

Sound Bank – Use these letters

cl or oa igh a ow er aw u ss er sp oy et

Containers

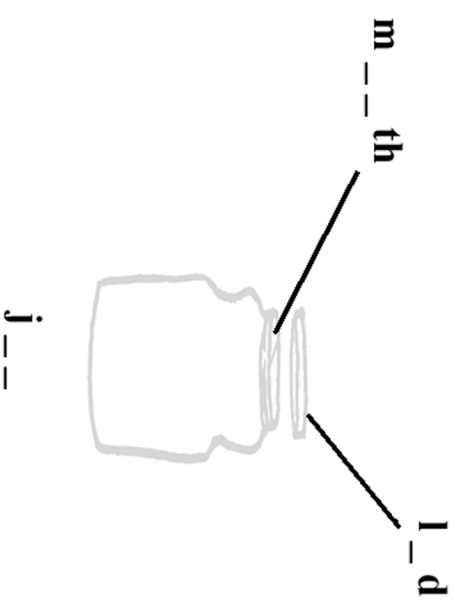

Word Bank
 neck
 spout
 handle (3)
 jug
 pitcher
 jar
 bottle
 mouth (4)
 lid (2)
 cork
 milk jug
 cap

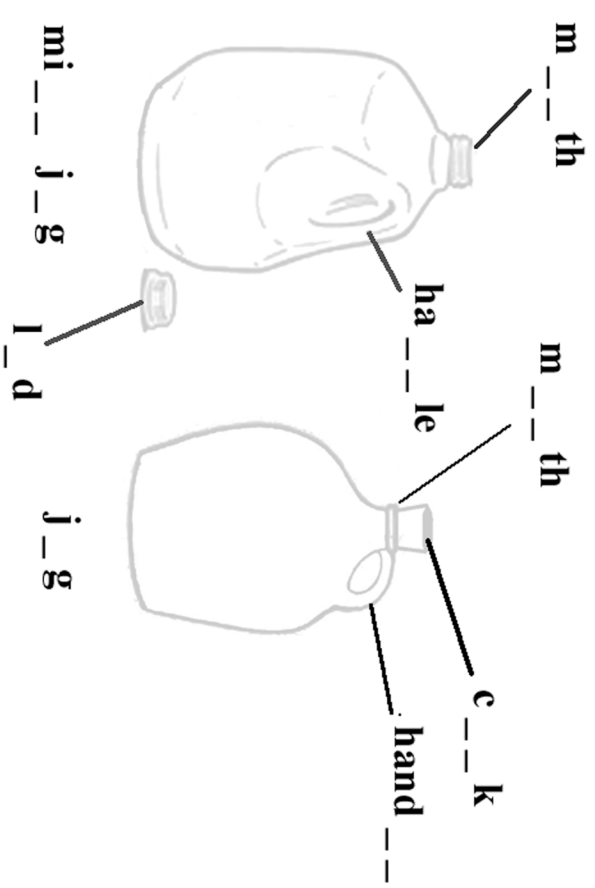
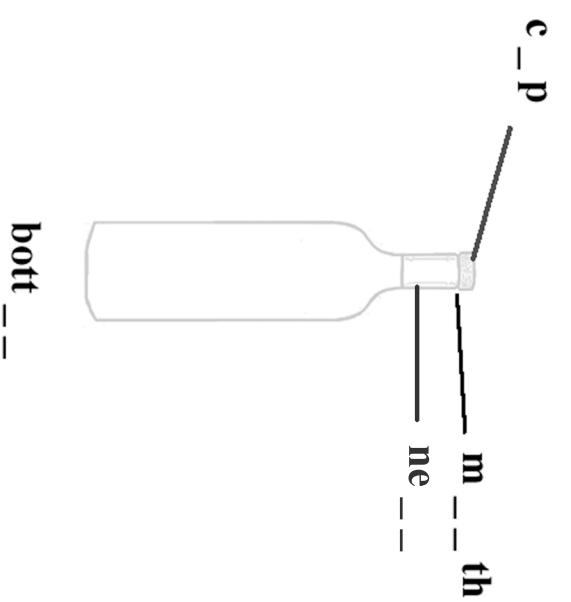

Sound Bank – Use these letters

le ou ou u or lk u ou le i i ou a le ar ch nd ck

Containers



b _ _ g (sa _ _ _)



p _ _ _ l (bu _ _ _ et)

hand _ _ _



bask _ _ _



b _ _ x (b _ _ n) (t _ _ b)

Word Bank

tub
sack
bin
handle
bucket
basket
bag
pail
box

Sound Bank – Use these letters

ai et u ck a ck o le i

Parts of a Door

- Word Bank
- sill
 - hinge (3)
 - doorjamb
 - trim
 - threshold
 - doorknob

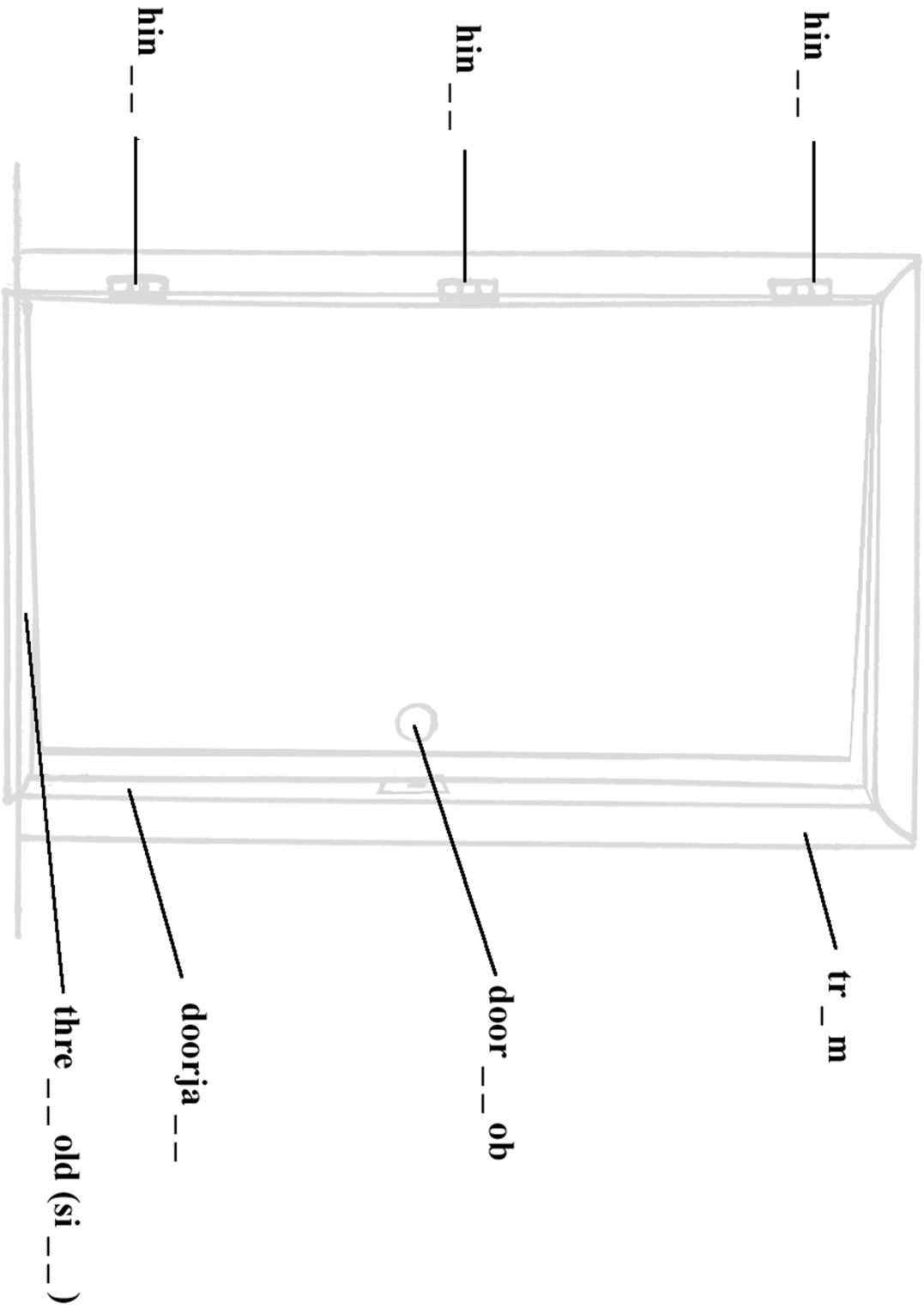

Sound Bank – Use these letters

mb sh i ll ge kn ge ge

Parts of a Living Room

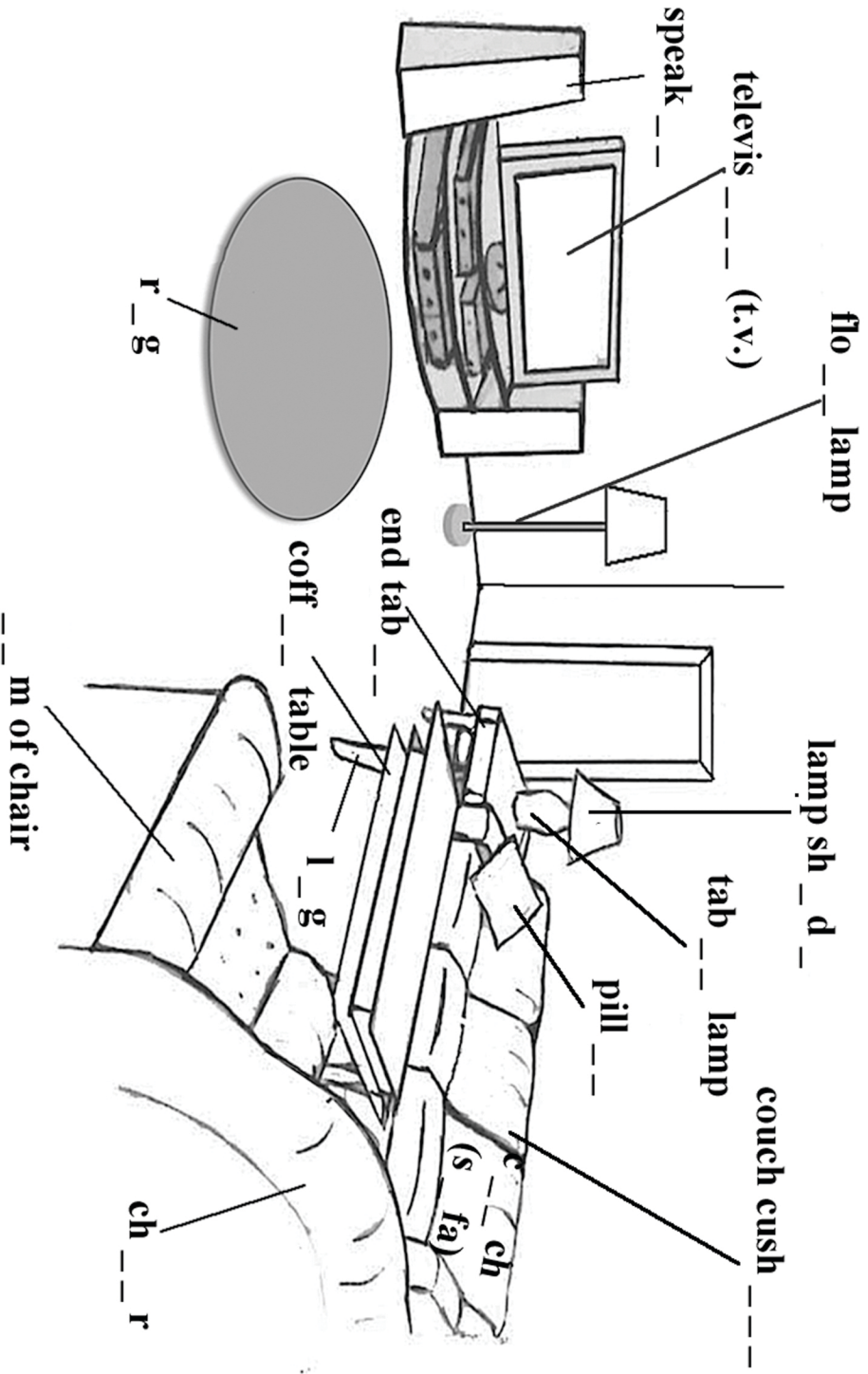

- Word Bank**
- rug
 - pillow
 - chair
 - speaker
 - television
 - sofa
 - floor lamp
 - table lamp
 - couch
 - coffee table
 - arm of chair
 - couch cushion
 - end table
 - leg
 - lamp shade

Sound Bank – Use these letters

le e ow ion or ou a_e u er o ion ee ar le ai

Parts of a Kitchen

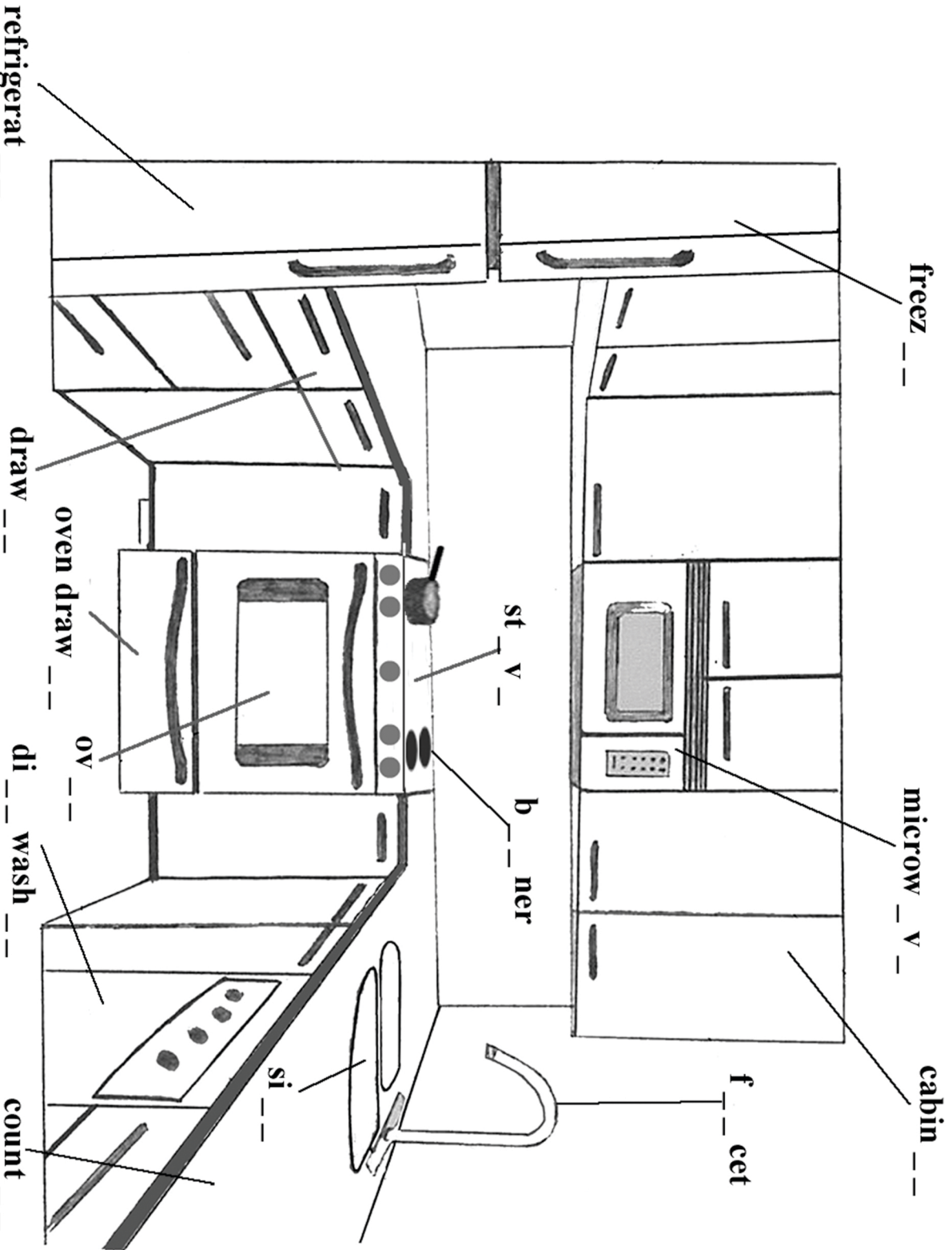

- Word Bank**
- counter
 - refrigerator
 - dishwasher
 - stove
 - oven
 - oven drawer
 - freezer
 - microwave
 - sink
 - faucet
 - cabinet
 - drawer
 - burner

Sound Bank – Use these letters

refrigerat ___
 freez ___
 microw ___ v ___
 cabin ___
 f ___ cet
 st ___ v ___
 b ___ ner
 ov ___
 oven draw ___
 di ___ wash ___
 si ___
 count ___
 or
 en
 nk
 ur
 et
 er
 o_e
 er
 sh
 er
 a_e
 er
 au
 er

Kitchen Utensils

Word Bank

- measuring spoons
- rolling pin
- knife
- mixing bowl
- funnel
- cutting board
- measuring cup

measuring sp _ _ _ ns

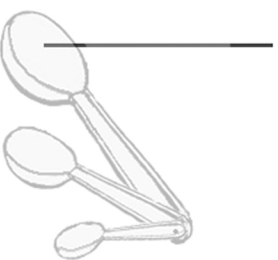

roll _ _ _ _ pin



funn _ _ _

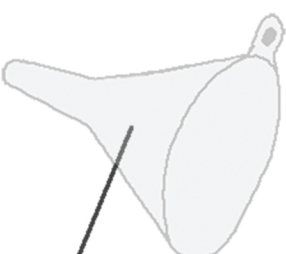

cu _ _ ing board

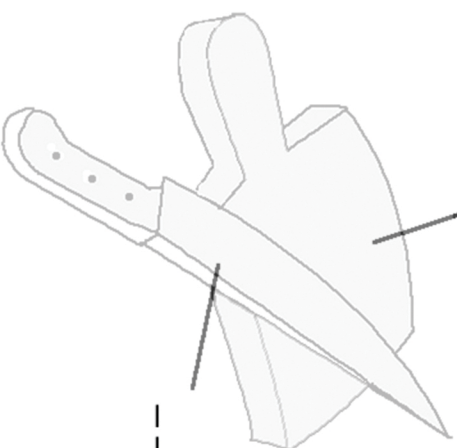

_ _ ife

m _ _ suring cup

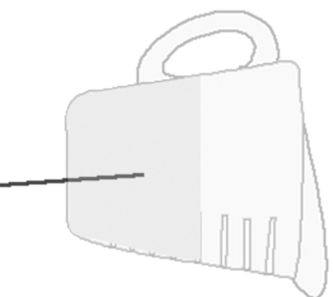

mixing b _ _ _ l



Sound Bank – Use these letters

ing el kn oo tt ow ea

Kitchen Utensils

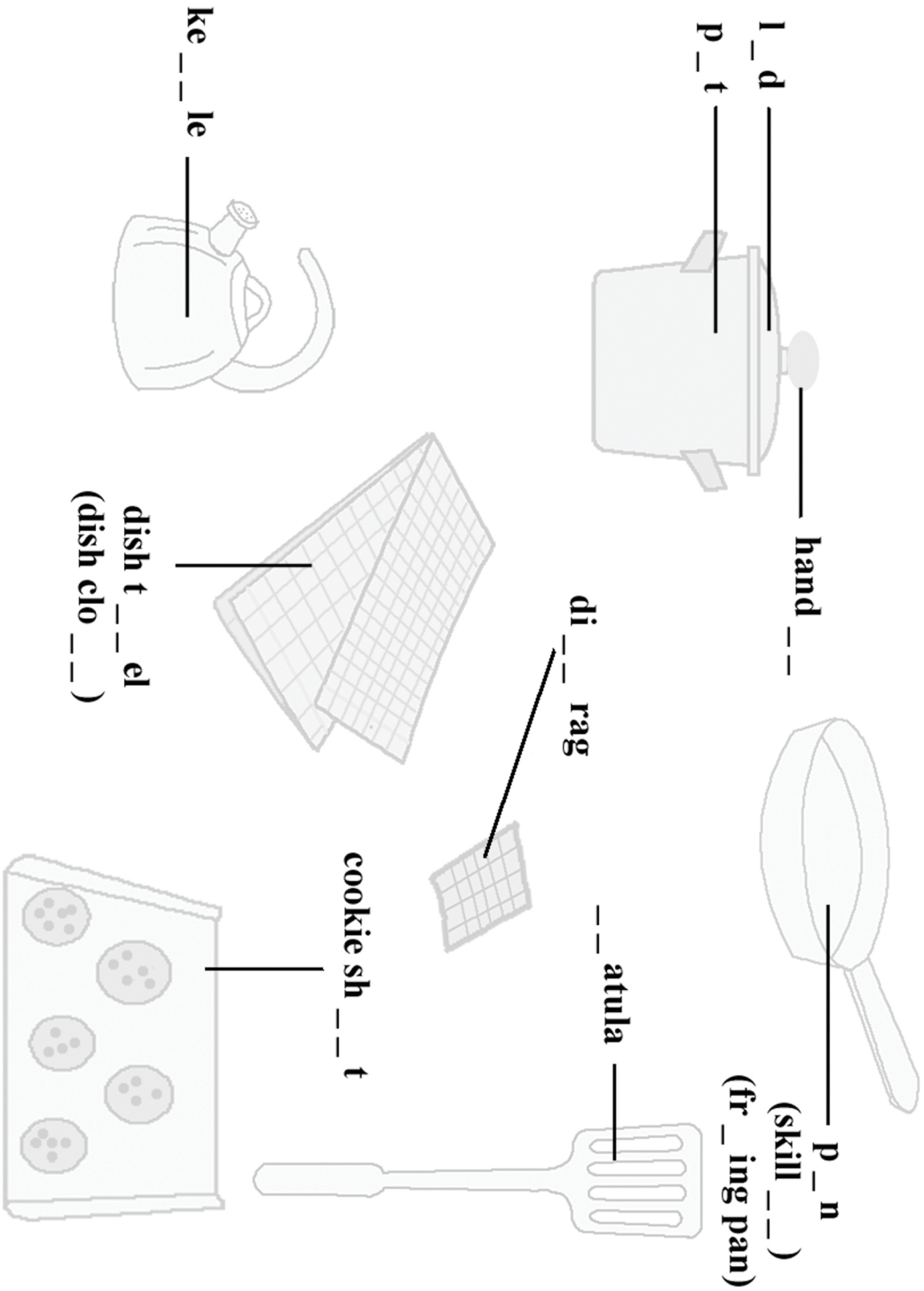

- Word Bank
- dish rag
 - spatula
 - lid
 - cookie sheet
 - kettle
 - pan
 - dish towel
 - skillet
 - handle
 - dish cloth
 - pot
 - frying pan

Sound Bank – Use these letters

y sh i le o et a ee sp ow tt th

Parts of a Table Setting

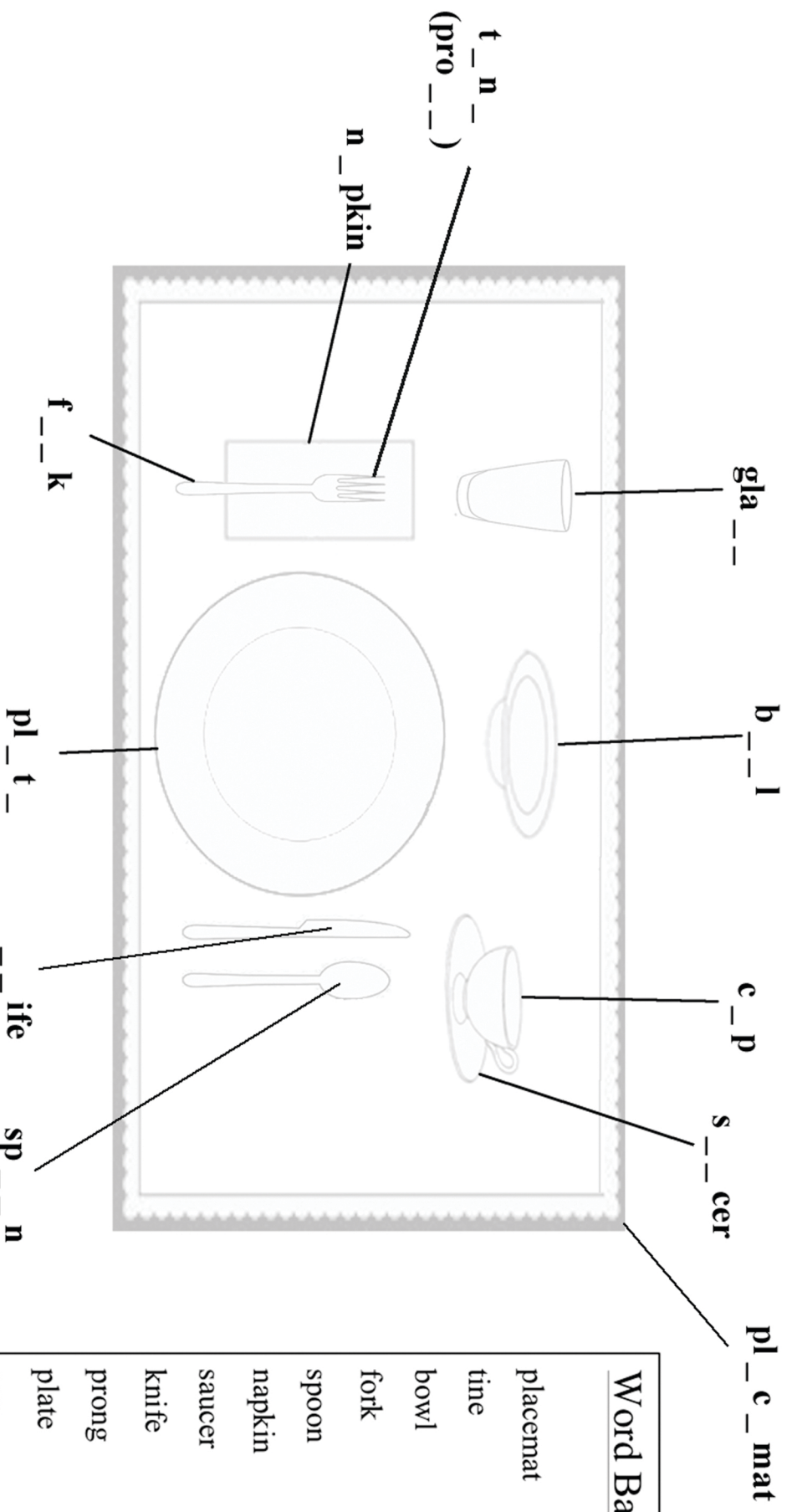

- Word Bank**
- placemat
 - tine
 - bowl
 - fork
 - spoon
 - napkin
 - saucer
 - knife
 - prong
 - plate
 - cup
 - glass

Sound Bank – Use these letters

ow u kn ss i_e oo a a_e ng au or a_e

Parts of a Flowering Plant

flow _ _ _ (blossom, bloom)

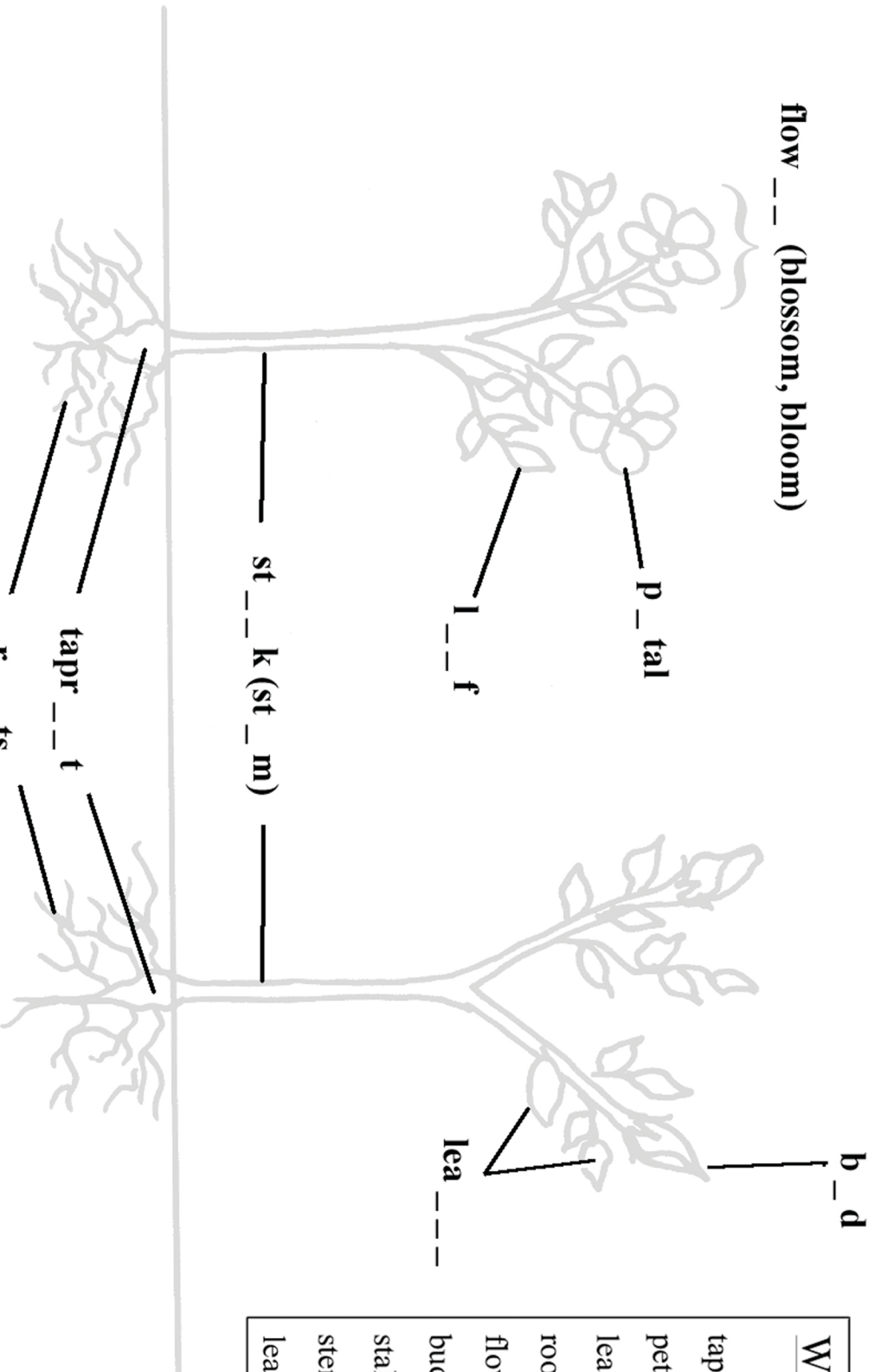

- Word Bank**
- taproot
 - petal
 - leaf
 - root
 - flower
 - bud
 - stalk
 - stem
 - leaves

Sound Bank – Use these letters

er e al oo e ea u oo ves

Parts of a Tree

Word Bank

leaves
taproot
bough
trunk
stump
leaf
log
roots
fork
twig
rings
limb
branch
bark

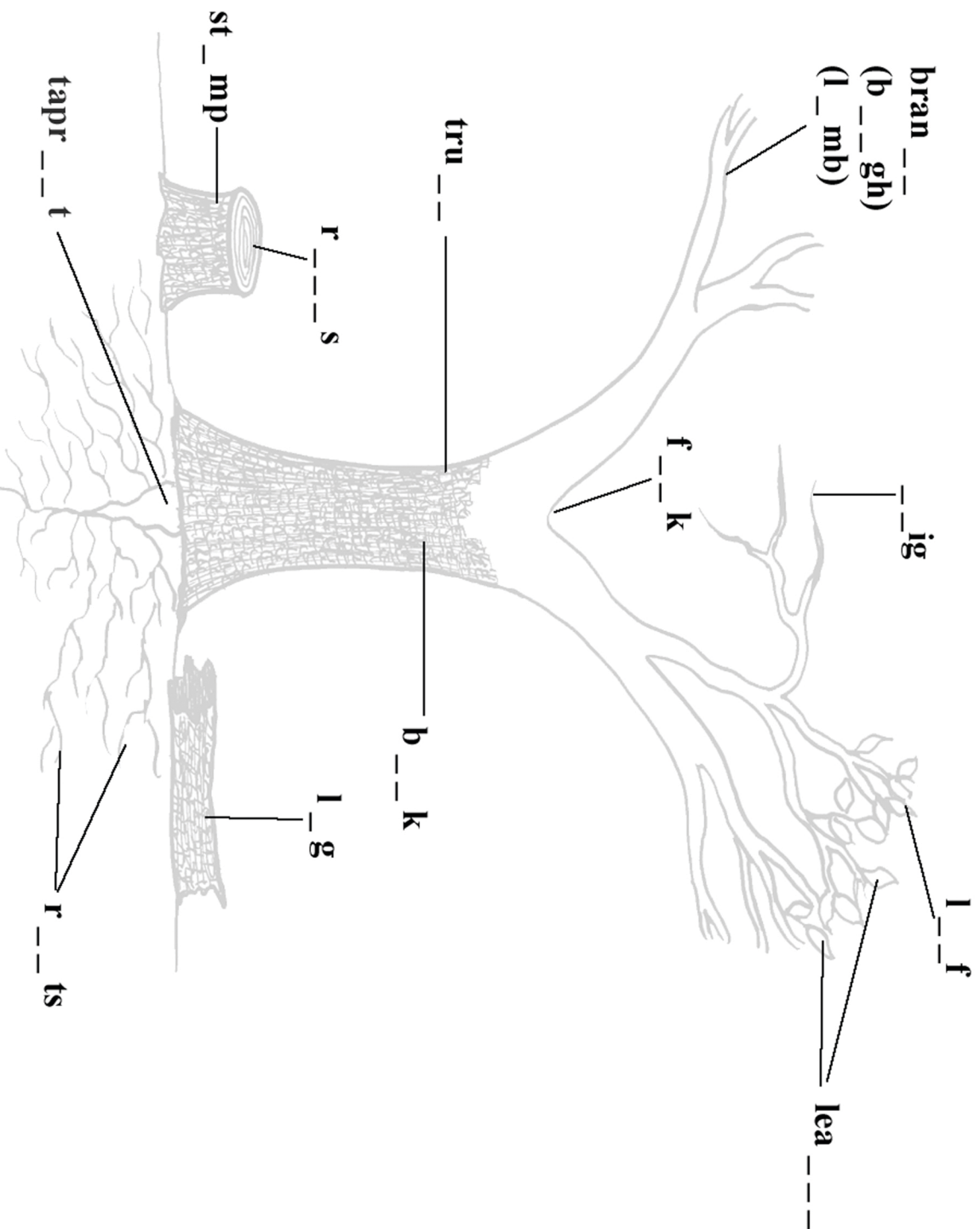

Sound Bank – Use these letters

ou u o ing ch oo or i tw ar nk oo ea ves

Tools for Gardening

Word Bank
rake
wheelbarrow
hoe
hand spade
shovel

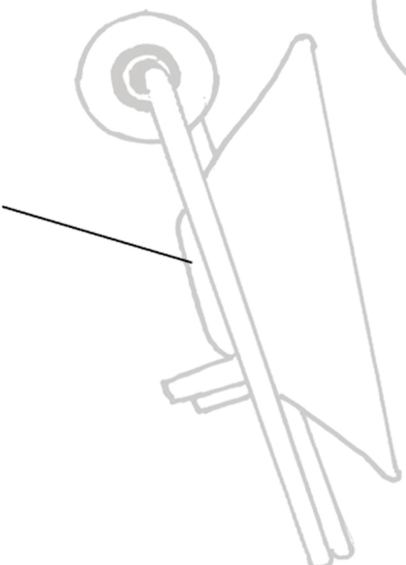
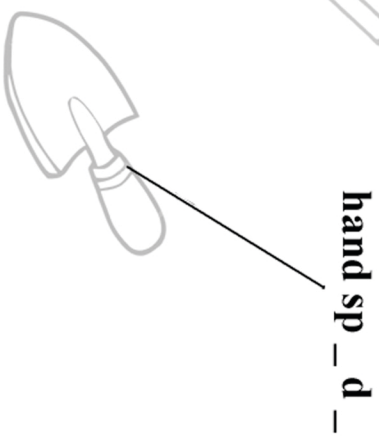
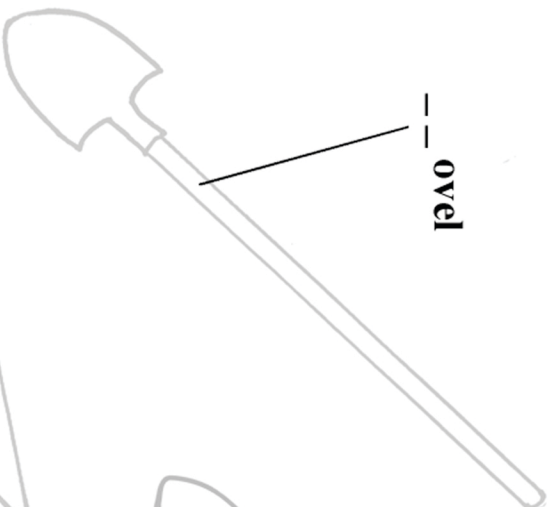

Sound Bank – Use these letters

oe ee a_e sh a_e ow

Parts of a Bicycle (Bike)

Word Bank

- reflector
- fender (2)
- handgrips
- wheel
- handlebars
- seat
- pedal
- spokes
- tire
- kickstand
- chain
- rim

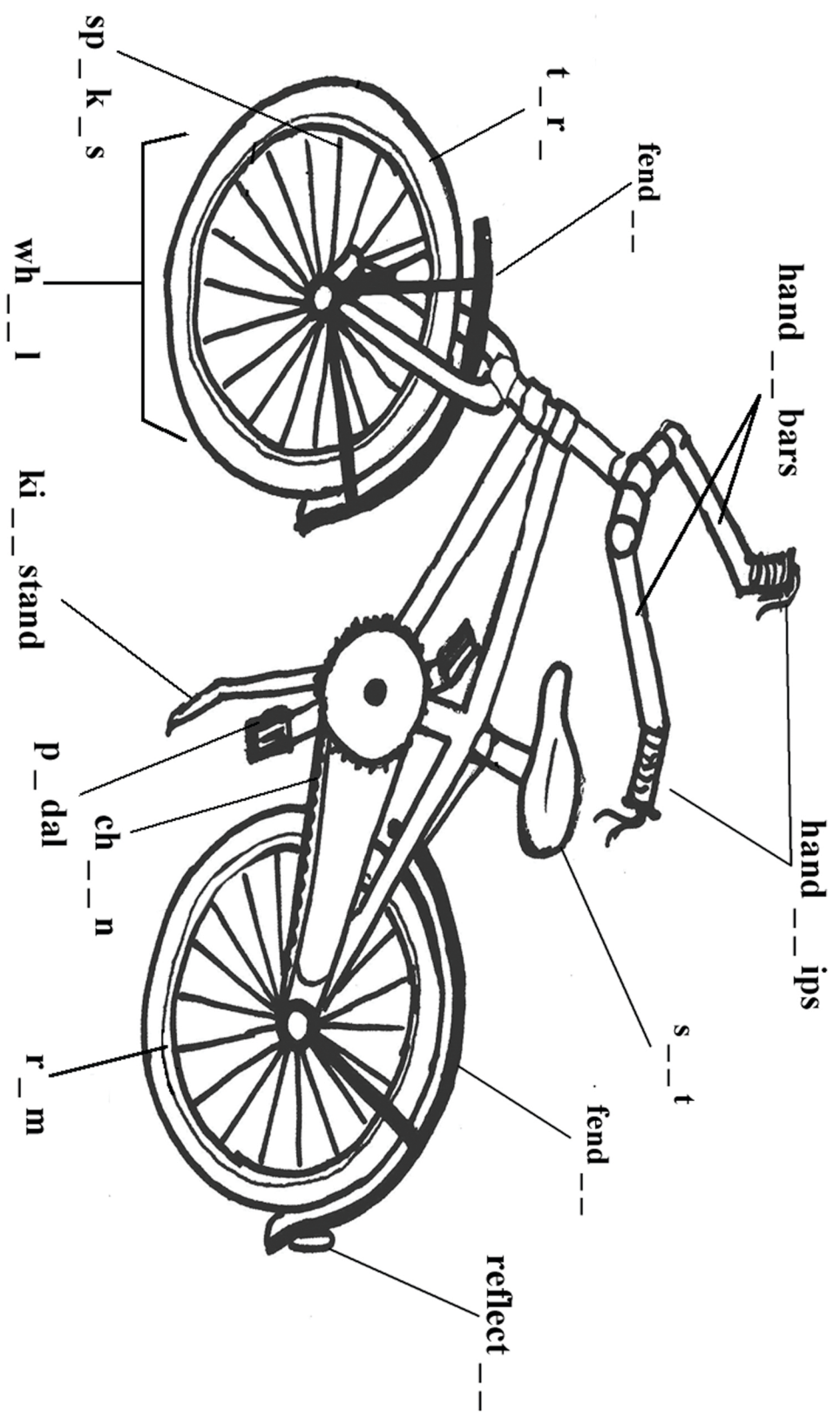

Sound Bank – Use these letters

i i_e e gr or ee o_e le ea ck ai er er

Parts of a Boat (Sailboat)

Word Bank

- portholes
- sail
- hull
- mast
- rudder
- deck
- anchor
- bow
- stern
- keel
- wheel
- helm

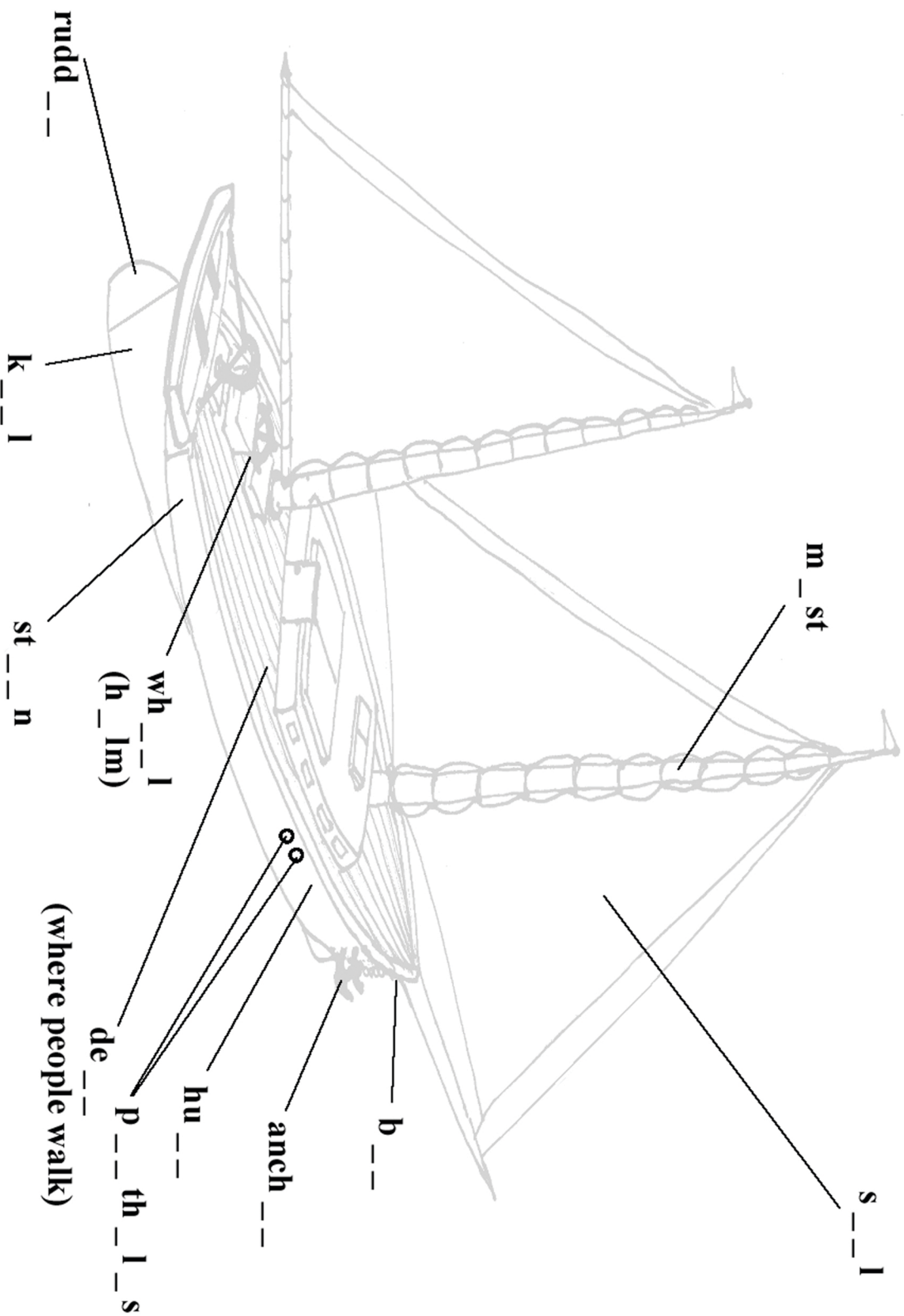

Sound Bank – Use these letters

o e er e ow ee ll ai er ee or a ck or

Boats Without Motors



r _ ft



padd _ _ _

can _ _ _

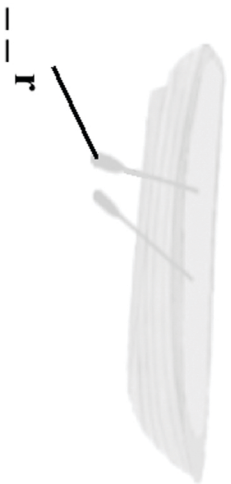

r _ _ b _ _ t

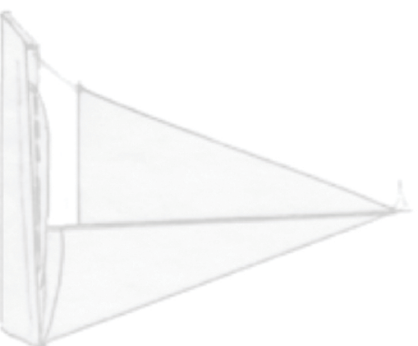

s _ _ lboat

Word Bank

sailboat
paddle
canoe
raft
oar
rowboat

Sound Bank – Use these letters

oe ai le a oa ow oa

Parts of the Side of a Car

Word Bank

- tires
- hood
- roof
- trunk
- bumper (2)
- wheels
- tailpipe
- side view mirror
- headlight
- taillight
- side window
- windshield

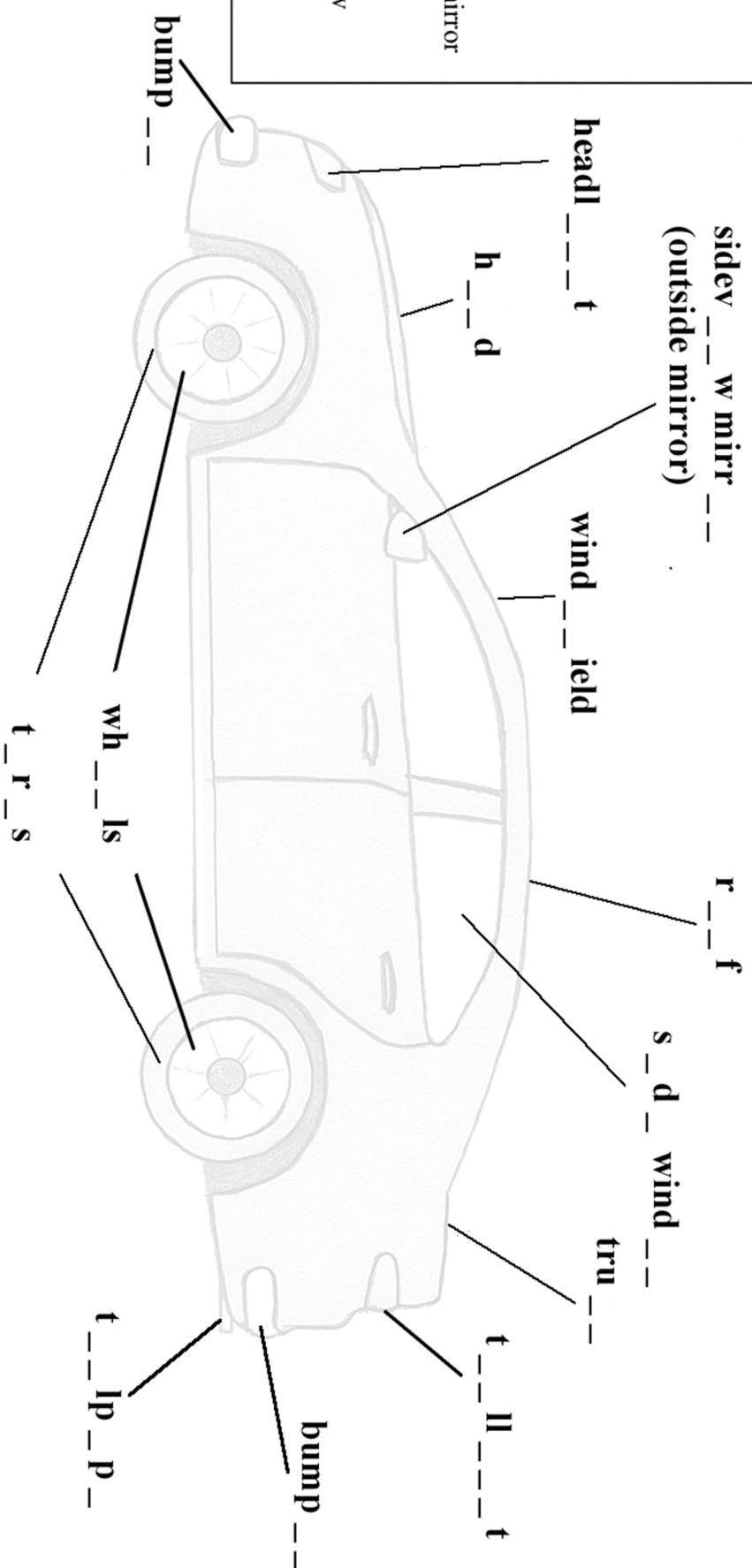

Sound Bank – Use these letters

- igh
- er
- sh
- ee
- oo
- i_e
- oo
- i_e
- i_e
- ai
- ai
- nk
- or
- ie
- ow
- igh
- er

Animal Feet



h _ _ f (top) h _ _ f (underside)



cloven h _ _ f



we _ _ ed f _ _ t

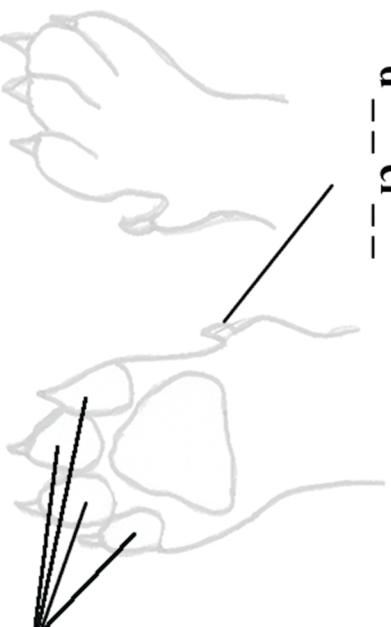

d _ _ cl _ _

p _ _ (top)

p _ _ (underside)

dig _ _ al pads

- Word Bank**
- cloven hoof
 - paw (2)
 - webbed feet
 - hoof (2)
 - digital pads
 - dewclaw

Sound Bank – Use these letters

aw ee oo it oo aw bb ew aw oo

Parts of a Bird

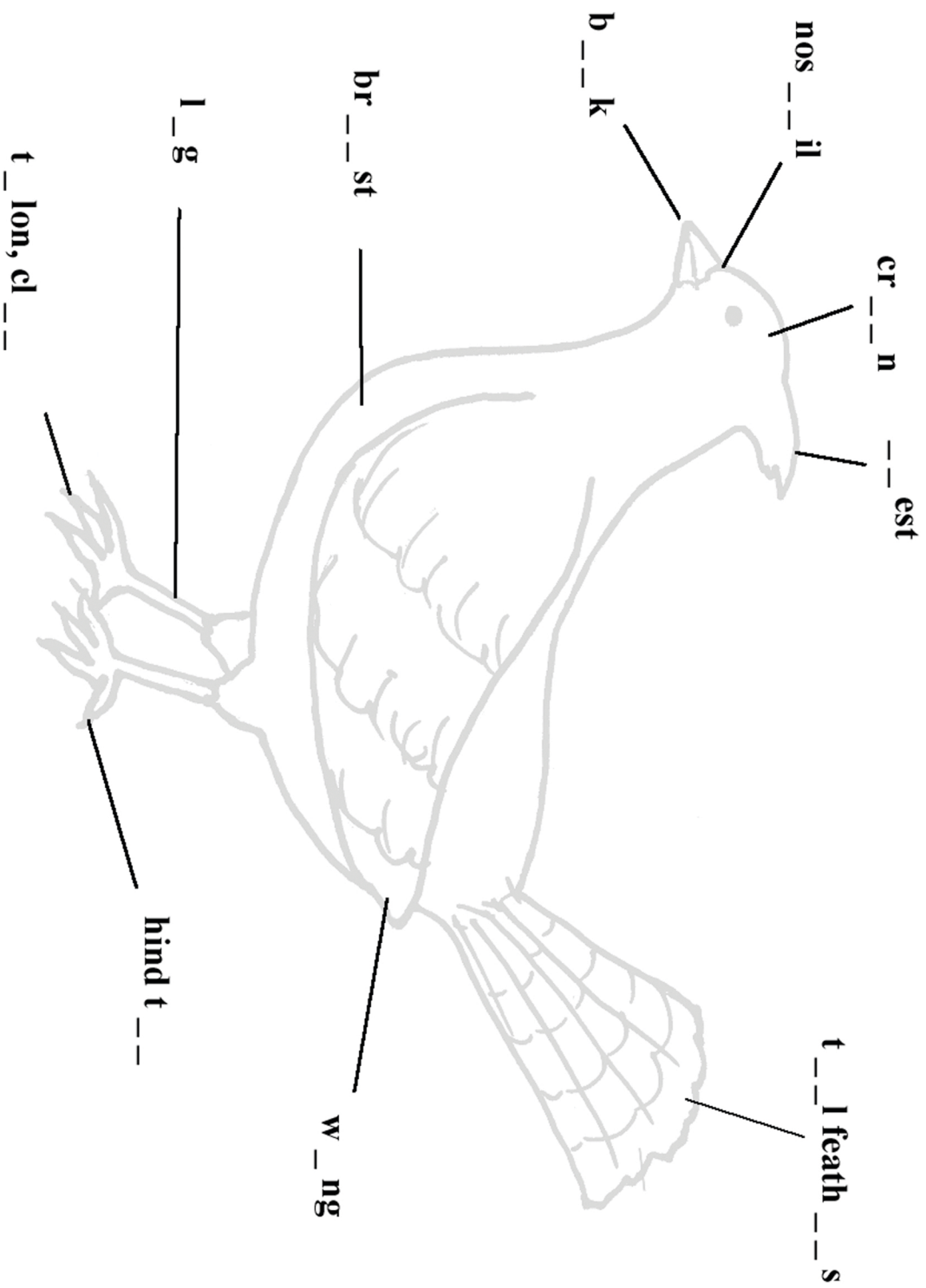

Word Bank

tail feathers
beak
hind toe
crest
breast
wing
leg
nostril
talon
crown
claw

Sound Bank – Use these letters

i tr a cr ai ea er ea aw e oe ow

Parts of a Dog and His Stuff

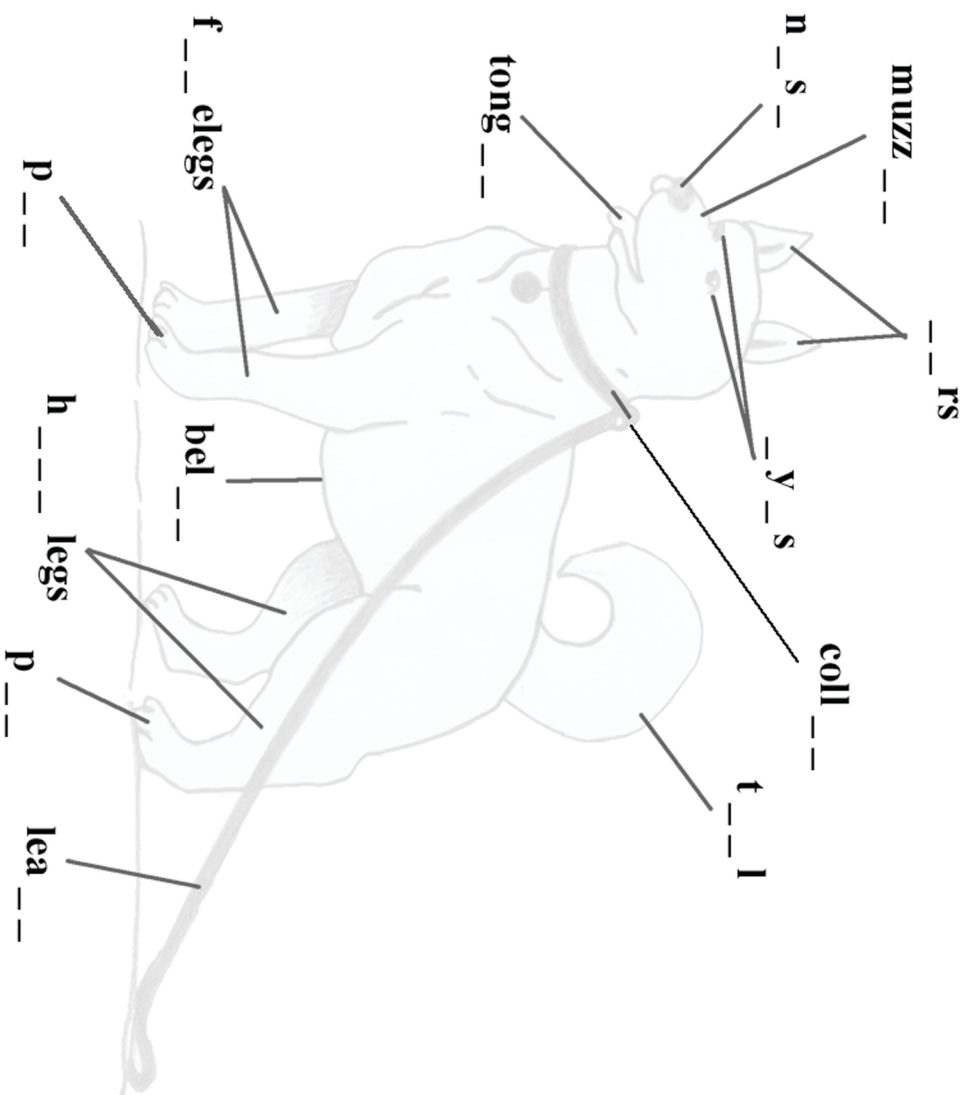

Word Bank

hind legs
ears
eyes
tail
nose
leash
paw (2)
tongue
forelegs
muzzle
collar
belly

Sound Bank – Use these letters

ai e_e ue or ly ind ar sh ea aw le o_e aw

Parts of a Horse

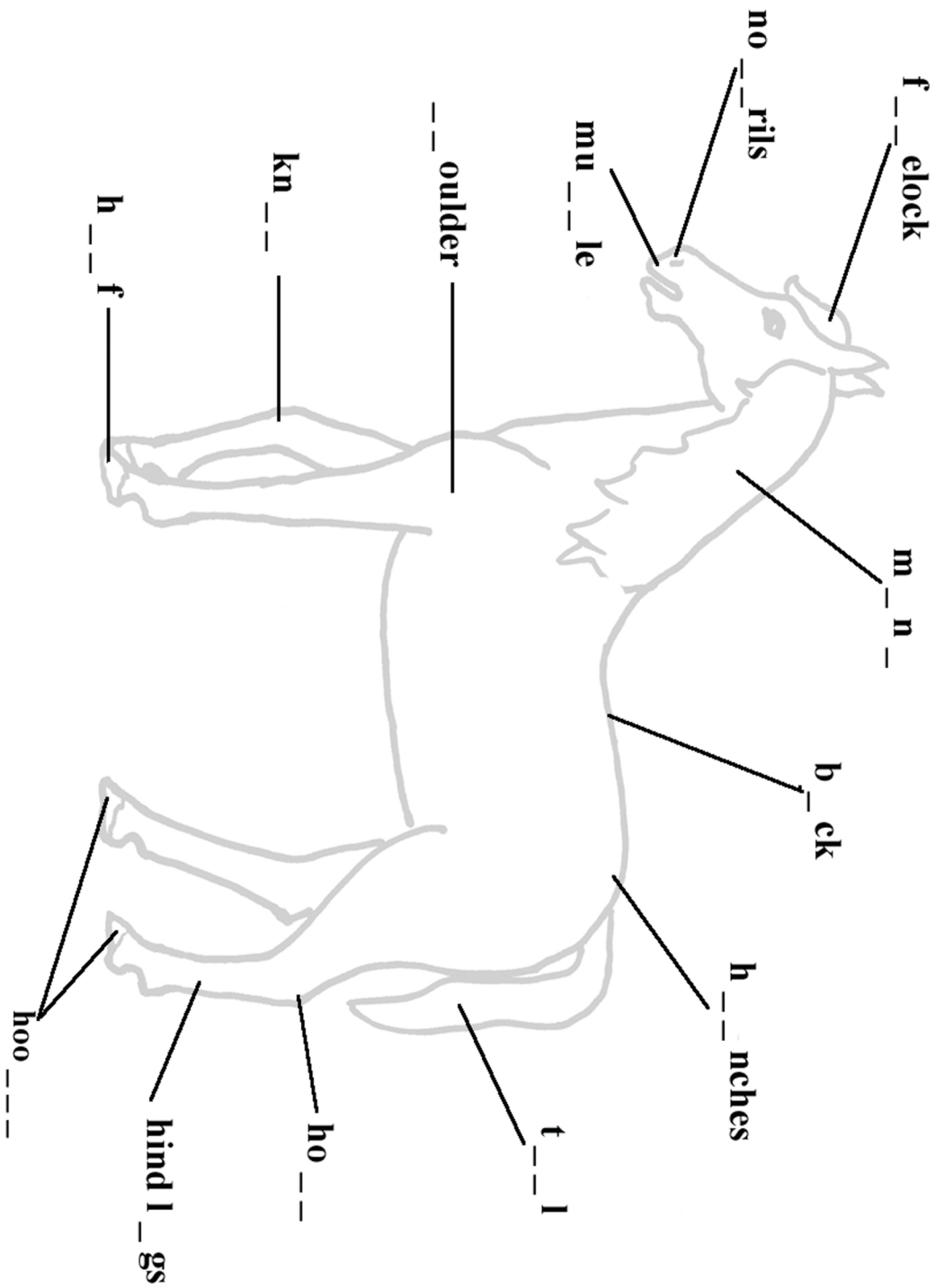

Word Bank

hooves
 hind legs
 mane
 knee
 hoof
 tail
 forelock
 back
 shoulder
 muzzle
 haunches
 nostrils
 hock

Sound Bank – Use these letters

a_e oo a e zz st ai sh au ck or ee ves

All Rights Reserved. No part of this book may be reproduced or transmitted in any form or by any means without the written permission of the author.

What We Call Male (boy), Female (girl), and Baby Animals

Animal	Male	Female	Baby
bear	boar	sow	cub
chicken	rooster	hen	chick
deer	buck, stag	doe	fawn
duck	drake	duck	duckling
horse	stallion	mare	foal
lion	lion	lioness	cub
cow	bull steer	heifer (before having a calf) cow (after having a calf)	calf
pig	boar	sow	piglet
spider			spiderling
goat	buck	nanny	kid

What We Call Groups of Animals

Animal	Group of Them
birds, sheep	flock
cow, horse,	herd
dogs, wolves	pack
fish	school
whales, dolphins	pod
bees	swarm
snake	bed
ants	colony